

Drainage

Channel Drain SOLID INSERT

Product Codes

FDTB 800 SS | FDTB 800 SS Black | FDTB 800 GM | FDTB 800 Brass

FDTB 900 SS | FDTB 900 SS Black | FDT 900 GM

FDTB 1000 SS | FDTB 1000 SS Black | FDTB 1000 GM | FDTB 1000 Brass

FDTB 1200 SS | FDTB 1200 SS Black | FDTB 1200 GM | FDTB 1200 Brass

Dimensions (mm)

800/900/1000/1200(l) x 69(w) x 21(d)mm

Beautiful and highly durable palette of 4 exquisite finishes (Brushed Stainless/Black/Brushed Gunmetal/Brushed Brass)



CHANNEL DRAIN BRUSHED SS



CHANNEL DRAIN BLACK



CHANNEL DRAIN BRUSHED GUNMETAL



CHANNEL DRAIN BRUSHED BRASS

Features

- Superior fall/centre outlet
- High grade stainless steel
- Manufactured from high quality maintenance-free materials
- 5 year warranty
- Minimum required Waste flange Ø50mm

Drawing

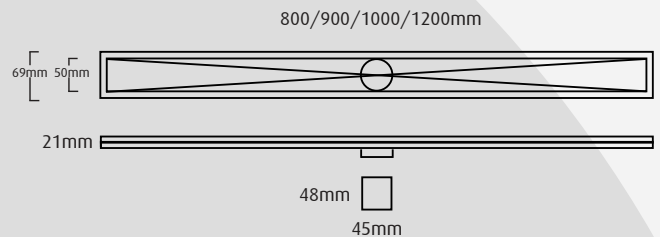

Diagram

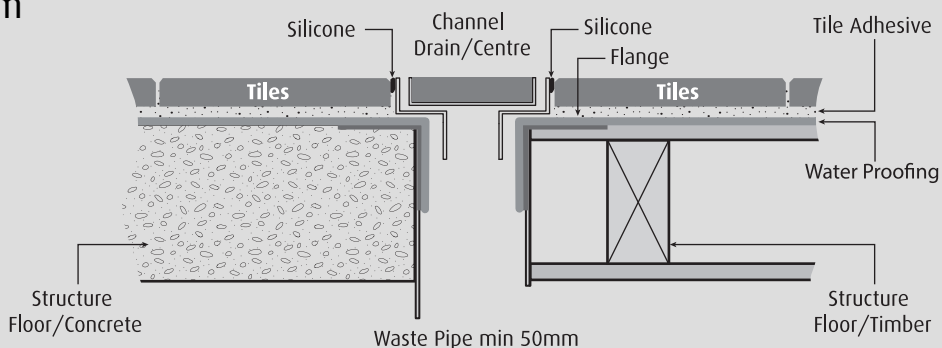

Drainage

Channel Drain TILE INSERT

Beautiful and highly durable palette of 4 exquisite finishes
(Polished Stainless/Black/Brushed Gunmetal/Brushed Brass)



Product Codes

FDT 800 | FDT 800 Black | FDT 800 GM | FDT 800 Brass

FDT 900 | FDT 900 Black | FDT 900 GM | FDT 900 Brass

FDT 1000 | FDT 1000 Black | FDT 1000 GM | FDT 1000 Brass

FDT 1200 | FDT 1200 Black | FDT 1200 GM | FDT 1200 Brass

FDT1800

Dimensions (mm)

800/900/1000/1200(l) x 69(w) x 21(d) mm

1800 (l) x 69(w) x 25(d) mm



CHANNEL DRAIN TILE INSERT

Features

- Superior fall/centre outlet
- High grade stainless steel
- Manufactured from high quality maintenance-free materials
- 5 year warranty
- Minimum required Waste flange Ø50mm

Drawing

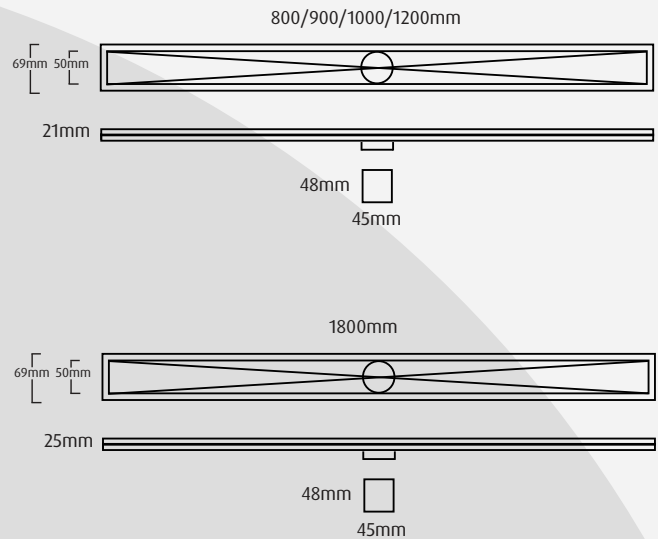

Diagram

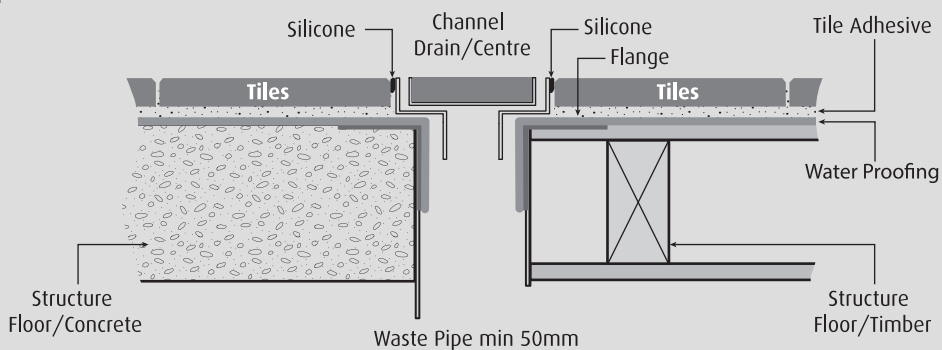

Drainage

Channel Drain LINEAR

Product Code

FDL 800 | FDL 1000 | FDL 1200

Dimensions (mm)

800(l) x 69(w) x 21(d)mm

1000(l) x 69(w) x 21(d)mm

1200(l) x 69(w) x 21(d)mm

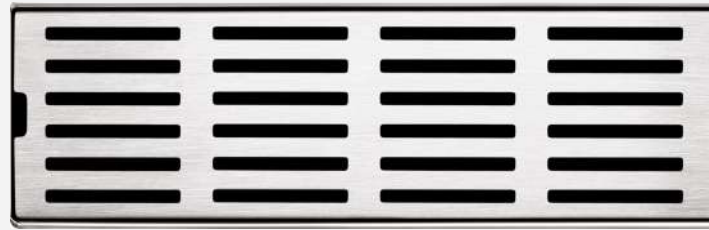

CHANNEL DRAIN LINEAR

Features

- Superior fall/centre outlet
- High grade stainless steel
- Manufactured from high quality maintenance-free materials
- 5 year warranty
- Minimum required Waste flange Ø50mm

Drawing

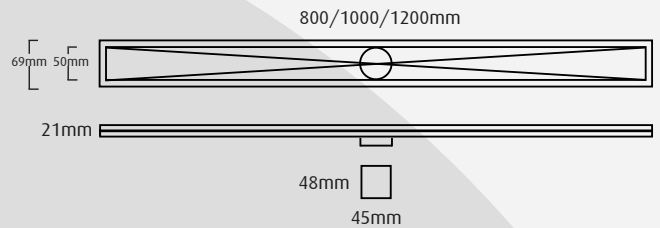

Diagram

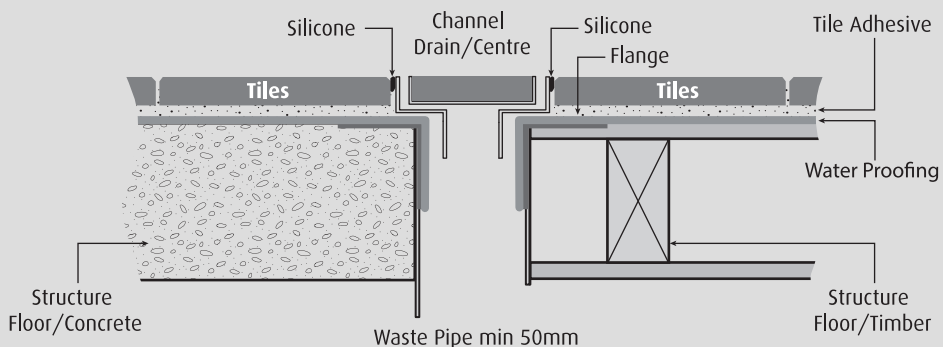

Drainage

Channel Drain MESH

Product Code

FDM 800 | FDM 900 | FDM 1000
| FDM 1200 | FDM 1800

Dimensions (mm)

800(l) x 69(w) x 21(d)mm
900(l) x 69(w) x 21(d)mm
1000(l) x 69(w) x 21(d)mm
1200(l) x 69(w) x 21(d)mm
1800(l) x 69(w) x 21(d)mm

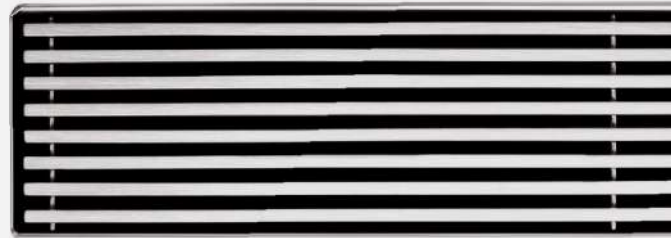

CHANNEL DRAIN MESH

Features

- Superior fall/centre outlet
- High grade stainless steel
- Manufactured from high quality maintenance-free materials
- 5 year warranty
- Minimum required Waste flange Ø50mm

Drawing

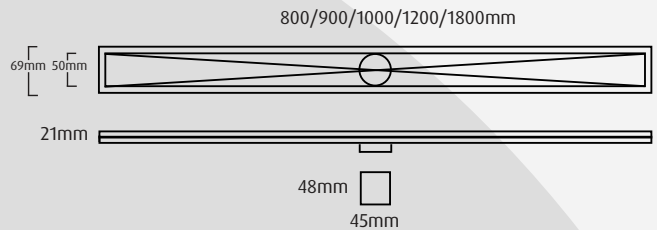

Diagram

