

# Drainage

## Channel Drain SOLID BRUSHED SS

### Product Codes

FDTB 800 SS | FDTB 800 SS Black | FDTB 800 GM | FDTB 800 Brass

FDTB 900 SS | FDTB 900 SS Black | FDT 900 GM

FDTB 1000 SS | FDTB 1000 SS Black | FDTB 1000 GM | FDTB 1000 Brass

FDTB 1200 SS | FDTB 1200 SS Black | FDTB 1200 GM | FDTB 1200 Brass

### Dimensions (mm)

800/900/1000/1200(l) x 69(w) x 21(d)mm

Beautiful and highly durable palette of 4 exquisite finishes (Brushed Stainless/Black/Brushed Gunmetal/Brushed Brass)



CHANNEL DRAIN BRUSHED SS



CHANNEL DRAIN BLACK



CHANNEL DRAIN BRUSHED GUNMETAL



CHANNEL DRAIN BRUSHED BRASS

## Features

- Superior fall/centre outlet
- High grade stainless steel
- Manufactured from high quality maintenance-free materials
- 5 year warranty
- Minimum required Waste flange Ø50mm

## Drawing

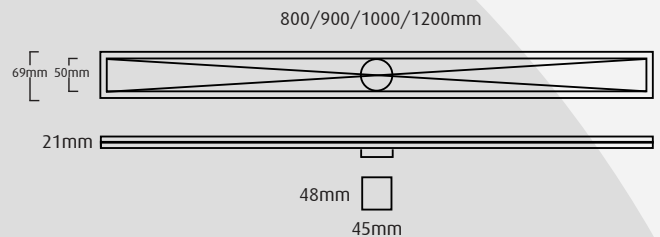

## Diagram

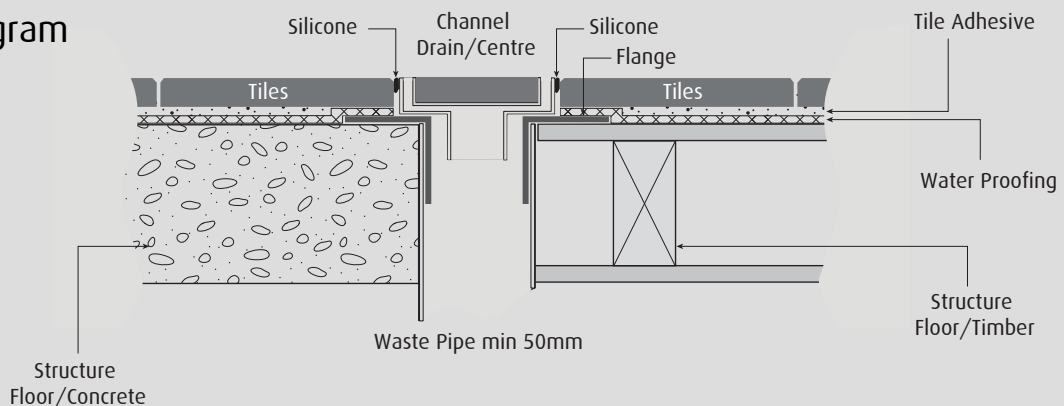

# Drainage

## Channel Drain LINEAR

Product Code  
FDL 800 | FDL 1000 | FDL 1200

Dimensions (mm)  
800(l) x 69(w) x 21(d)mm  
1000(l) x 69(w) x 21(d)mm  
1200(l) x 69(w) x 21(d)mm

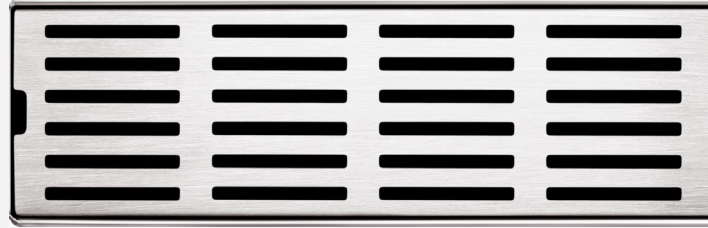

CHANNEL DRAIN LINEAR

### Features

- Superior fall/centre outlet
- High grade stainless steel
- Manufactured from high quality maintenance-free materials
- 5 year warranty
- Minimum required Waste flange Ø50mm

### Drawing

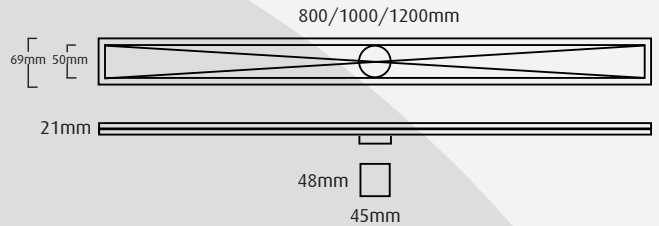

### Diagram

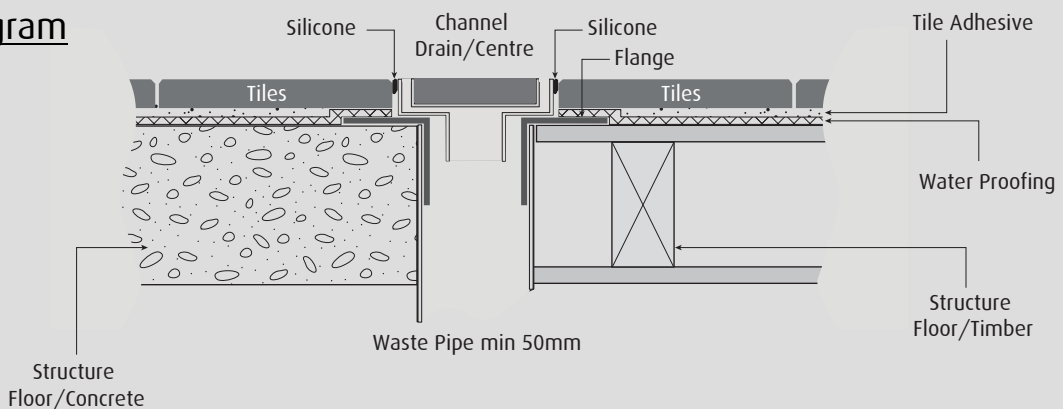

# Drainage

## Channel Drain MESH

### Product Code

FDM 800 | FDM 900 | FDM 1000  
| FDM 1200 | FDM 1800

### Dimensions (mm)

800(l) x 69(w) x 21(d)mm  
900(l) x 69(w) x 21(d)mm  
1000(l) x 69(w) x 21(d)mm  
1200(l) x 69(w) x 21(d)mm  
1800(l) x 69(w) x 21(d)mm

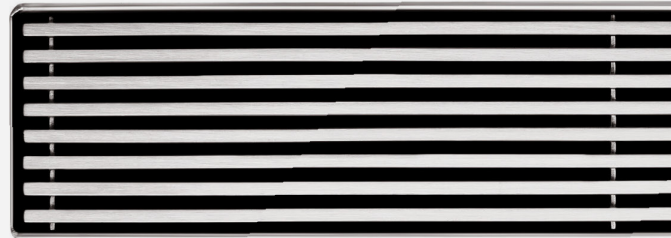

CHANNEL DRAIN MESH

## Features

- Superior fall/centre outlet
- High grade stainless steel
- Manufactured from high quality maintenance-free materials
- 5 year warranty
- Minimum required Waste flange Ø50mm

## Drawing

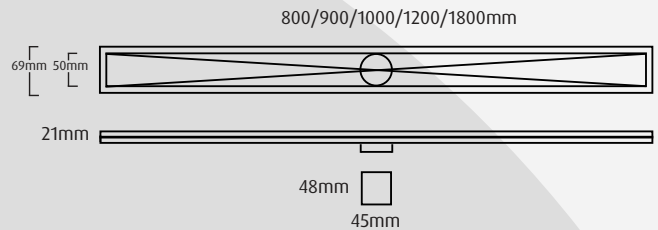

## Diagram

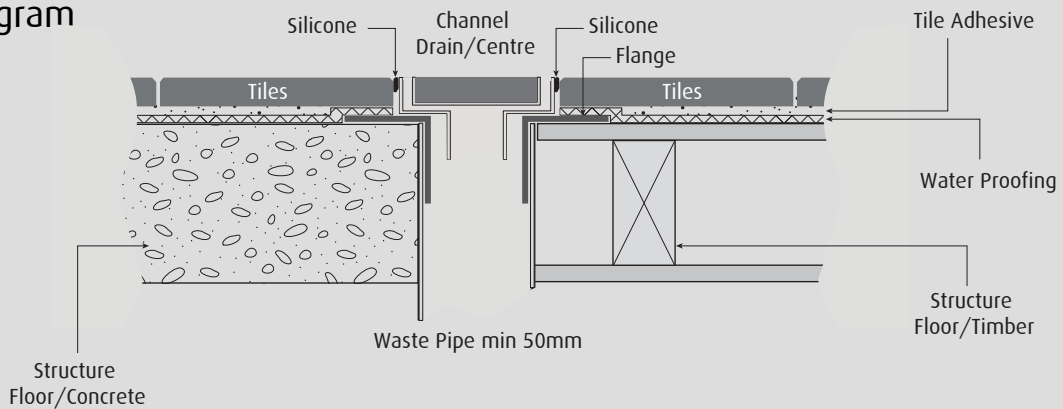

# Drainage

## Channel Drain TILE INSERT

### Product Code

FDT 800 | FDT 900 | FDT 1000 |  
FDT 1200 | FDT 1800

### Dimensions (mm)

800(l) x 69(w) x 21(d)mm  
900(l) x 69(w) x 21(d)mm  
1000(l) x 69(w) x 21(d)mm  
1200(l) x 69(w) x 21(d)mm  
1800(l) x 69(w) x 25(d)mm



CHANNEL DRAIN TILE INSERT

## Features

- Superior fall/centre outlet
- High grade stainless steel
- Manufactured from high quality maintenance-free materials
- 5 year warranty
- Minimum required Waste flange Ø50mm

## Drawing

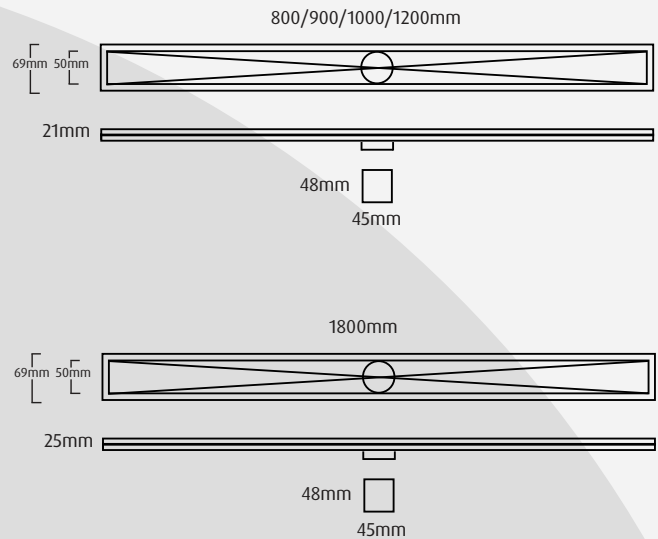

## Diagram

