

Data Sheets

Accessories

Tranquillity Square



Paper holder SQUARE

Tranquillity Square Accessories

Product code: BA11-5/ BA11-5 Black/ BA11-5 BSS/ BA11-5 GM/ BA11-5 Brass

Dimensions: 165(w) x 40(h) x 100(d) mm

tranquillity
bathroomware

Features

Guaranteed for 5 years against manufacturing defects • Easily installed into new or existing bathrooms.



Polished STAINLESS STEEL
Code: BA11-5

AVAILABLE IN **5** finishes



POLISHED
STAINLESS



JAGUAR
BLACK



BRUSHED
STAINLESS



BRUSHED
GUN-METAL



BRUSHED
BRASS

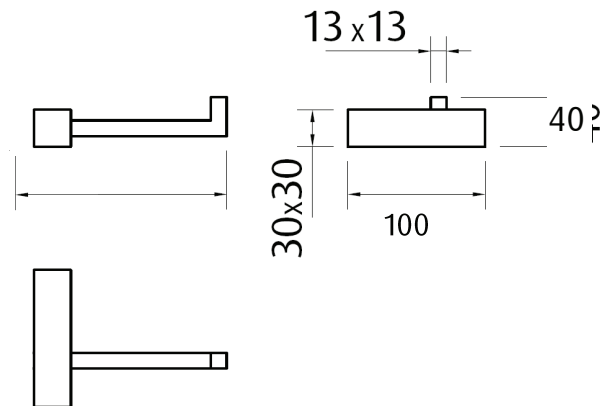

Note: Manufacturing tolerances could cause variances of ± 5 mm.



Single robe hook SQUARE

Tranquillity Square Accessories

Product code: BA11-3/ BA11-3 Black/ BA11-3

BSS/ BA11-3 GM/ BA11-3 Brass

Dimensions: 30(w) x 50(h) x 60(d) mm

tranquillity
bathroomware

Features

Guaranteed for 5 years against manufacturing defects • Easily installed into new or existing bathrooms.



Polished STAINLESS STEEL

Code: BA11-3

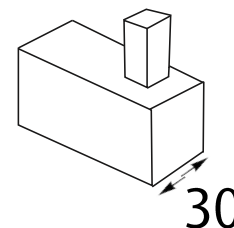
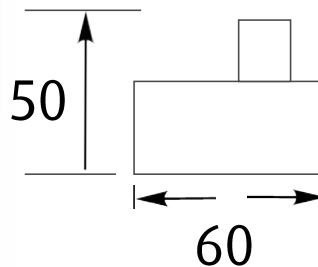

AVAILABLE IN 5 finishes



POLISHED
STAINLESS



JAGUAR
BLACK



BRUSHED
STAINLESS



BRUSHED
GUN-METAL



BRUSHED
BRASS

Note: Manufacturing tolerances could cause variances of ± 5 mm.



Toilet brush holder SQUARE

Tranquillity Square Accessories

Product code: BA11-11/ BA11-11 Black/
BA11-11 BSS/BA11-11 GM

Dimensions: 90(w) x 30(h) x 133(d) mm

tranquillity
bathroomware

Features

Guaranteed for 5 years against manufacturing defects •
Easily installed into new or existing bathrooms.



Polished STAINLESS STEEL
Code: BA11-11



Jaguar Black STAINLESS STEEL
WITH MATT BLACK FINISH
Code: BA11-11 Black



Brushed STAINLESS STEEL
WITH BRUSHED FINISH
Code: BA11-3 BSS



Brushed GUN-METAL
Code: BA11-3 GM

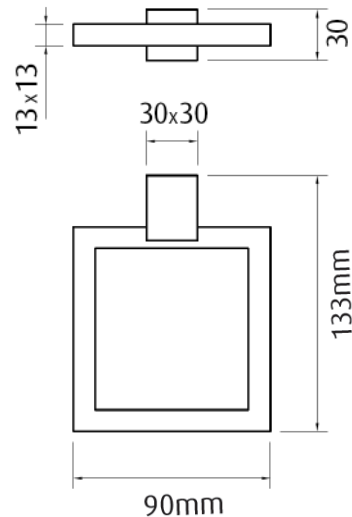

AVAILABLE IN 4 finishes



POLISHED
STAINLESS



JAGUAR
BLACK



BRUSHED
STAINLESS



BRUSHED
GUN-METAL

Note: Manufacturing tolerances could cause
variances of ± 5 mm.



5
YEAR
WARRANTY

Singe towel rail SQUARE

Tranquillity Square Accessories

Product code: BA11-8 300/ BA11-8 300 Black
BA11-8 300 BSS/BA11-8 300 GM

Dimensions: 100(w) x 30(h) x 370(l) mm

Features

Guaranteed for 5 years against manufacturing defects •
Easily installed into new or existing bathrooms.



Polished STAINLESS STEEL
Code: BA11-8 300



Jaguar Black STAINLESS STEEL
WITH MATT BLACK FINISH
Code: BA11-8 300 Black



Brushed STAINLESS STEEL
WITH BRUSHED FINISH
Code: BA11-8 300 BSS



Brushed GUN-METAL
Code: BA11-8 300 GM

tranquillity
bathroomware

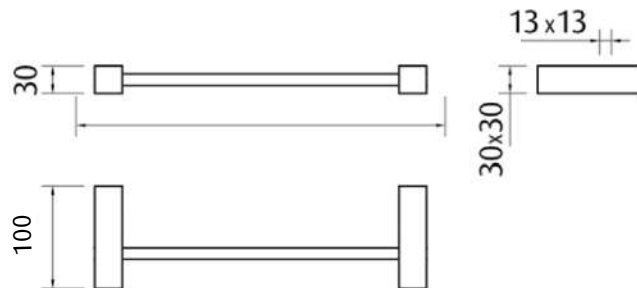

AVAILABLE IN 4 finishes



POLISHED
STAINLESS



JAGUAR
BLACK



BRUSHED
STAINLESS



BRUSHED
GUN-METAL

Note: Manufacturing tolerances could cause
variances of ± 5 mm.



5
YEAR
WARRANTY

Single towel rail SQUARE

Tranquillity Square Accessories

Product code: BA11-8 600/ BA11-8 600 Black
BA11-8 600 BSS/BA11-8 600 GM

Dimensions: 100(w) x 30(h) x 670(l) mm

Features Guaranteed for 5 years against
manufacturing defects • Easily installed into new or
existing bathrooms.



Polished STAINLESS STEEL
Code: BA11-8 600



Jaguar Black STAINLESS STEEL
WITH MATT BLACK FINISH
Code: BA11-8 600 Black



Brushed STAINLESS STEEL
WITH BRUSHED FINISH
Code: BA11-8 600 BSS



Brushed GUN-METAL
Code: BA11-8 600 GM

tranquillity
bathroomware



AVAILABLE IN 4 finishes

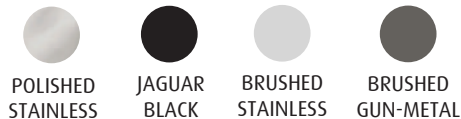

POLISHED
STAINLESS

JAGUAR
BLACK

BRUSHED
STAINLESS

BRUSHED
GUN-METAL

Note: Manufacturing tolerances could cause
variances of ± 5 mm.



5
YEAR
WARRANTY

Toughened glass shelf SQUARE

Tranquillity Square Accessories

Product code: BA11-13 450/BA11-13 600

Dimensions: 100(D) x 10(h) x 450/600(l) mm

Features

Guaranteed for 5 years against manufacturing defects • Easily installed into new or existing bathrooms.



Polished STAINLESS STEEL

Code: BA11-13 450/ BA11-13 600

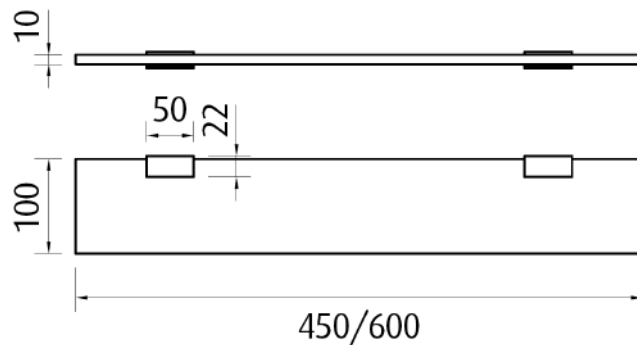

Note: Manufacturing tolerances could cause variances of ± 5 mm.



Corner shelf SQUARE

Tranquillity Square Accessories

tranquillity
bathroomware

Product code: **BA11-13 200**

Dimensions: 200(w) x 10(h) x 200(d) mm

Features

Guaranteed for 5 years against manufacturing defects • Easily installed into new or existing bathrooms.

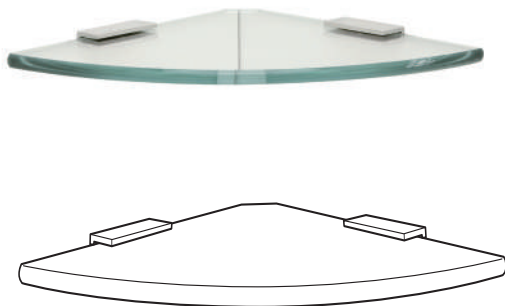

Polished STAINLESS STEEL

Code: BA11-13 200

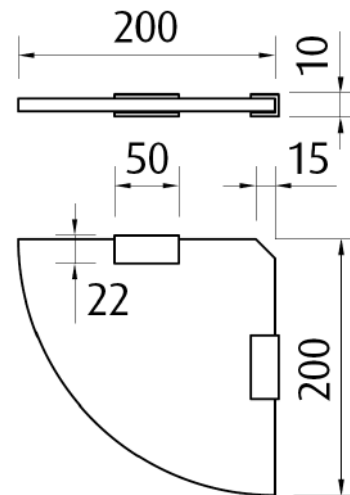

Note: Manufacturing tolerances could cause variances of ± 5 mm.



Towel holder SQUARE

Tranquillity Square Accessories

Product code: **BA11-6**

Dimensions: 265(d) x 150(h) x 670(l) mm

Features

Guaranteed for 5 years against manufacturing defects • Easily installed into new or existing bathrooms.

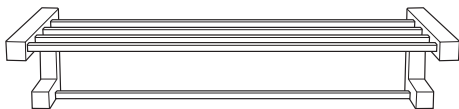

Polished STAINLESS STEEL
Code: BA11-6

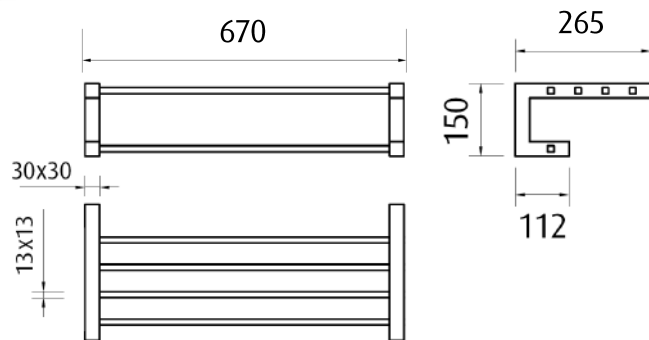

Note: Manufacturing tolerances could cause variances of ± 5 mm.



Double towel rail SQUARE

Tranquillity Square Accessories

Product code: **BA11-9**

Dimensions: 150(d) x 150(h) x 670(l) mm

Features

Guaranteed for 5 years against manufacturing defects • Easily installed into new or existing bathrooms.

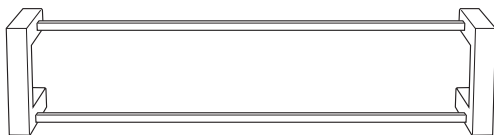

Polished STAINLESS STEEL
Code: BA11-9

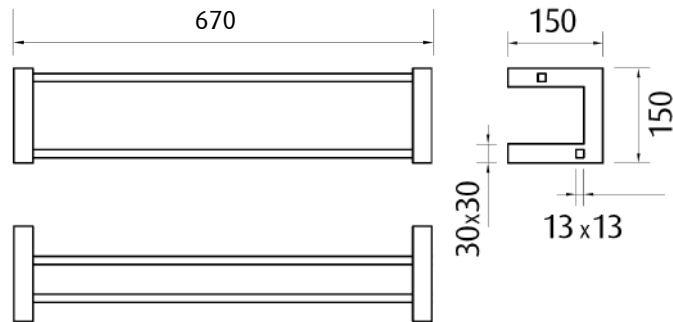

Note: Manufacturing tolerances could cause variances of ± 5 mm.

