

Models: ODHMONBLK (Black) & ODHMONSIL (Silver)



## Description

The Moderno infrared heater is a beautifully designed and modern wall or ceiling mounted heater.

## Application

Suited for indoor and outdoor areas such as terraces, cafes, balconies, apartments, houses, workshops, restaurants and bars.

## Specifications

Voltage	220-240V
Power	2000W
Hertz	50 Hz
Dimensions	900w x 130h x 89.5d mm
Weight	3.0 kg
IP Rating	IP55

## **Important Safety Instructions** – Read all instructions before installing and using this heater.

- The heater must be installed at least 1.8m above the floor.
- There must be a minimum distance of 200mm between the heater and the ceiling.
- The distance of your heater from the wall corners should be minimum 0.5m
- Do not cover your heater and do not hang any clothing over the heater. Do not place any clothing on or near the heater.
- This heater is designed for use on a 230 – 240V AC supply.
- Use this heater only as described in this manual. Any other use not recommended by the manufacturer may cause fire, electric shock or injury to persons.
- This heater is not intended for use by persons (including children) with reduced physical, sensory or mental capabilities, or lack of experience and knowledge, unless they have been given supervision or instruction concerning use of the appliance by a person responsible for their safety.
- Children should be supervised to ensure that they do not play with the appliance.
- The fireguard of this heater is intended to prevent direct access to heating elements and must be in place when the heater is in use.
- The fireguard does not give full protection for young children and infirm persons.
- This heater must be earthed. Connect to properly grounded outlets only.
- Ensure both plug and socket is clean and free from dust when using.
- To disconnect the heater from the power supply, turn the controls off, grip the plug and pull from the power socket. Never pull by the cord.
- Never touch the plug with wet or moist hands.
- Do not use an extension cord with this heater unless connected via a RCD device.
- Regularly inspect the power cord and plug for wear or damage. In order to avoid a hazard, do not operate the heater with a damaged cord, plug or loose socket or after the heater malfunctions or has been dropped or damaged in any manner.
- Do not use the heater if the heating element is cracked or broken.
- The heater must not be installed close to curtains and other combustible materials.
- The heater must not be located immediately below or in front of a socket outlet.
- **Switch off the heater using the "Rocker Switch" on the heater itself or using an isolation switch and/or unplug the heater from a wall socket whenever not in use. The remote control does not act as an isolating switch.**

## **Installation Instructions**

- The heater should be installed by a registered electrician if being hardwired.
- Always disconnect the heater from the electricity supply and allow it to cool before installation.
- This heater can be mounted either horizontally or vertically.
- The lowest part of the heater must be located at or above a minimum height of 1.8m from ground level, so that the heater cannot be touched when in operation.
- When mounting horizontally do not position the heater at an angle more than 90° and less than 45°.
- The supply cable must be at the lower end of the heater if the heater is installed at an angle or vertically.
- Keep the supply cord away from the body of the heater which will get hot during use.
- Do not use the heater on a flammable surface.
- Observe the minimum safe distance between the heater body and flammable surfaces when mounting.
- The heater should always have a minimum clearance of 200mm from a ceiling and adjacent walls.
- If the heater is to be used outside, a weatherproof outlet is recommended.

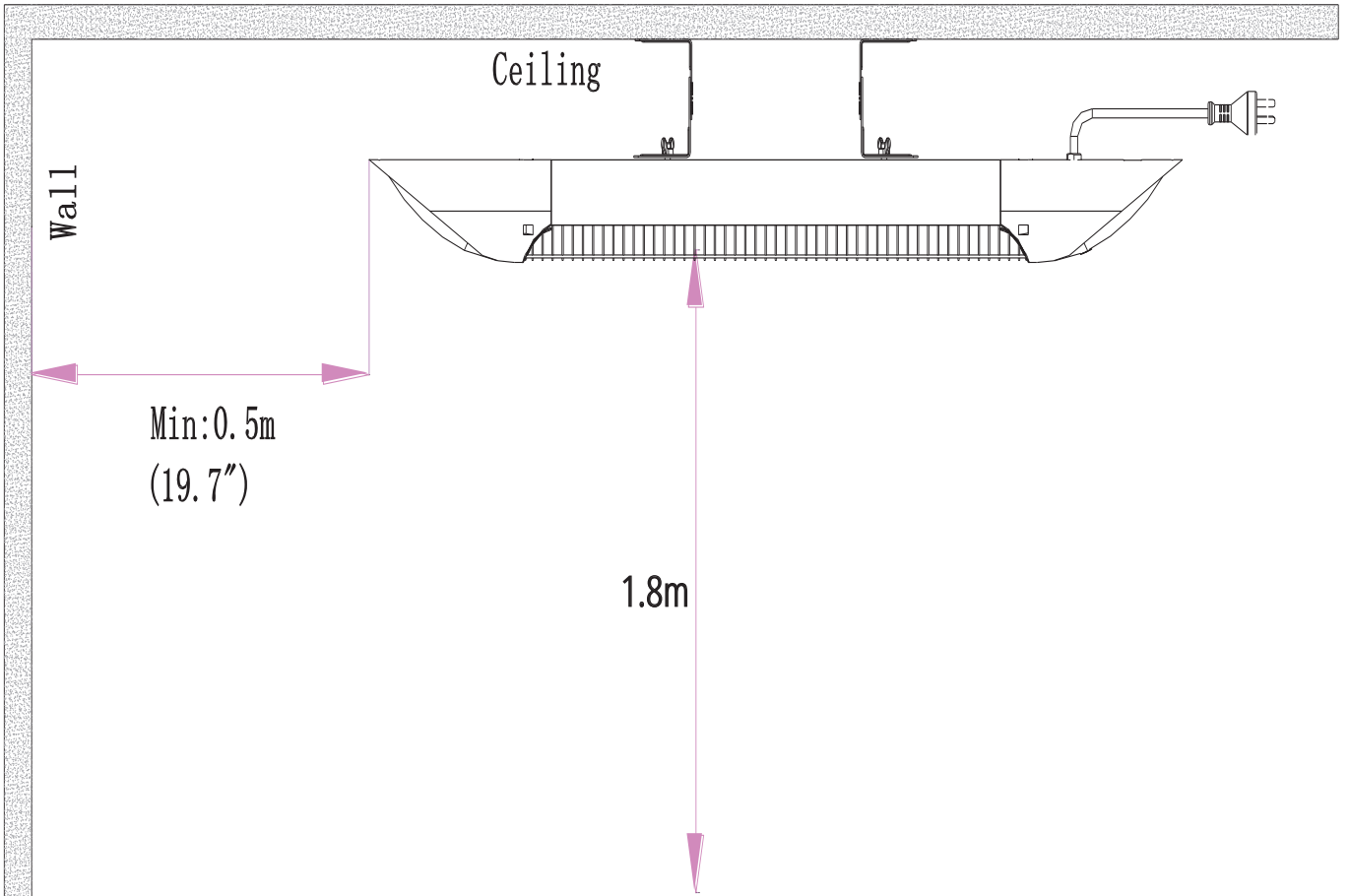
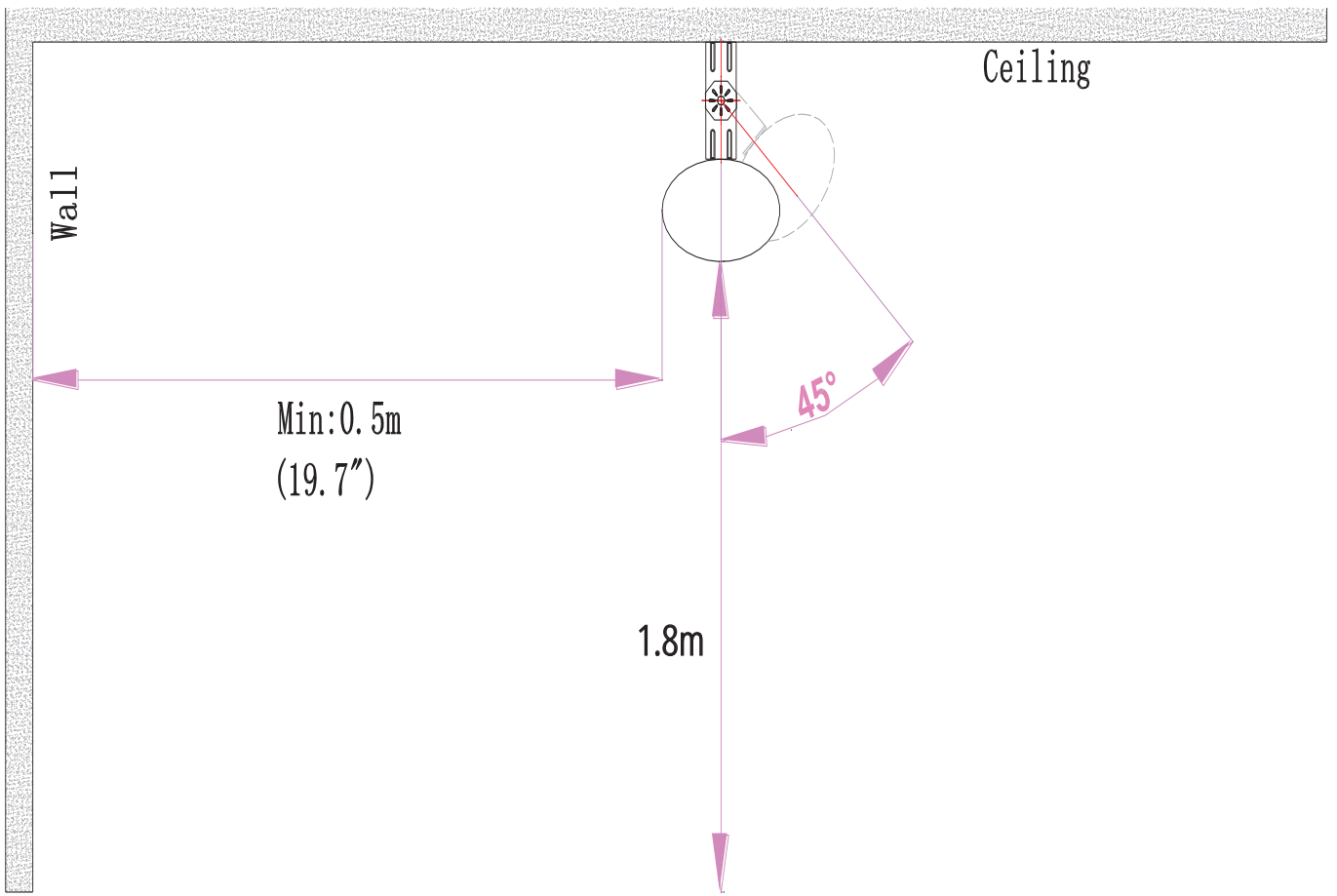

# Installation Instructions

- Before drilling ensure that there are no wires or water pipes in the area where the heater is to be installed.
- The heater must be installed on the mounting brackets provided.
- Fasten the brackets securely to the mounting surface and the backside of the heater using the nuts and screws supplied.
- Fasten the heater securely on the brackets using the nuts and bolts supplied.
- The brackets can be used to adjust the direction of the heater. Adjust the heater angle by loosening the two bolts on the wall mounting bracket. Tighten the bolts again when the desired angle is reached.
- For installation, a disconnecting/isolation switch incorporated in the fixed wiring (in accordance with the wiring rules) is to be provided.

**WARNING!** This heater is not equipped with a device to control the room temperature. Do not use this heater in small rooms when they are occupied by persons not capable of leaving the room on their own, unless constant supervision is provided.

**FIRE RISK EXISTS IF THE HEATER IS COVERED BY OR POSITIONED CLOSE TO CURTAINS OR OTHER COMBUSTIBLE MATERIALS.**

## 1. Products cannot be tightly installed

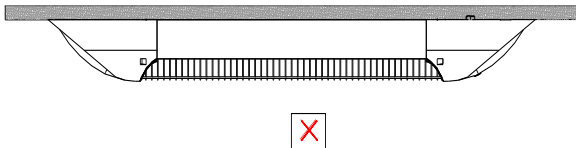

The product requires an L bracket to separate the product from the mounting plate

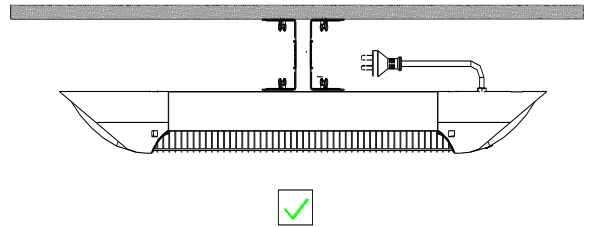

## 2. The product power cord cannot be mounted horizontally

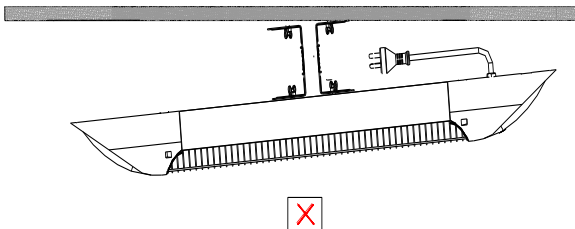

The product power cord can be installed downwards

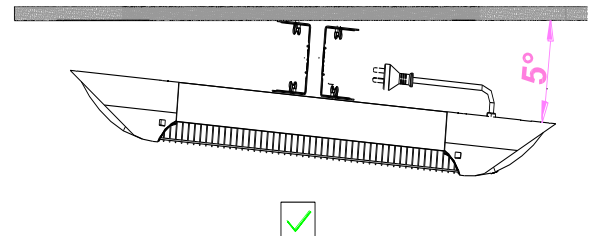

## Operating Instructions

Product Key Function:

1. Turn on the power, the product is standby mode display (--- ---);
2. Press key function: press the button, then press the 4P heat levels (L1-L2-L3-L4- standby - off)

## Remote Control Instructions

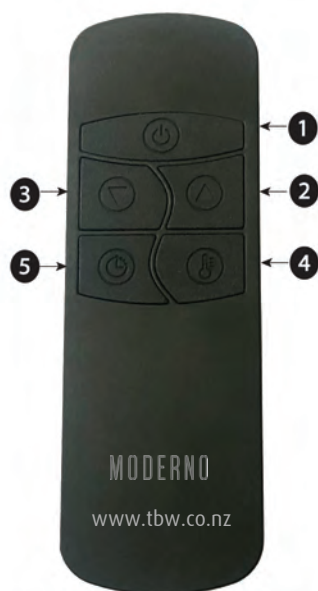

Remote Control Function			
Button	Function (Heater On)	Function ( Heater Off)	LED Display on Heater
1	Turns heater on or off		
2	Increase Heat Level or Timer hours	Turns heater on to Level 1 (minimum)	L1
3	Decrease Heat Level or Timer Hours	Turns heater on to Level 4 (maximum)	L4
4	Enable Heat Level adjustment		L (n)
5	Enable Timer adjustment	0-24	[0H] - [24H]

- POWER BUTTON:** Turn the heater off.
  - UP BUTTON:** Increase temperature, timer and level.
  - DOWN BUTTON:** Decrease temperature, timer and level.
  - LEVEL BUTTON:** Use to adjust the 4P heat levels(L1-L4). Press the Level button then use the up and down buttons (2 and 3) to increase or decrease the heating level.
  - TIMER BUTTON:** To set the timer from T0-T24, which is the number of hours it will run. T0 will display and then adjust to the number of hours you would like to set, using the up and down buttons (2 and 3).
- NOTE:** All heaters and their remote controls have the same frequency, so it is possible to control several heaters with just one remote.

## Inserting Batteries

Insert 2 AAA/ Alkaline type batteries into your remote control

- Flip the backside of your remote control and pull out battery cover. Insert the batteries in accordance with the instructions and polarity of the batteries.
- Change the batteries in the same way as depicted above.

### NOTICE:

- **Batteries not included.** Only use AAA/ Alkaline type batteries. Otherwise, your heater may not function well.
- Do not allow water or liquid to get into the remote control.

### Caution:

When the appliance is not operated for a long period of time, cleaning or maintenance is conducted or when the location of the heater is changed, the heater should be turned to OFF and unplugged from the electrical connection.

Periodic inspection and removal of dirt and contaminants will ensure that equipment can be operated safely.

## Troubleshooting

1. Check if the power cord is plugged into an electrical outlet, if not, plug in.
2. Check if electricity to the main fuse is working
3. Check to see if the thermostat knob is to the ON position
4. Check the thermostat setting, The heater may be off because it has reached the desired temperature setting.

## MAINTENANCE

**Attention!** Careful and regular maintenance of your heater considering our instructions assume great importance so as to attain a long efficient operation of your appliance.

- The Reflector and IR-Filament should be cleaned at least once a month. If necessary, apply cleaning and maintenance instructions.
- The number of checks may be increased considering the amount of the dust in the environment.
- Check the deformation of the Reflector, Wire and Frame visually while cleaning the appliance. In case of deformation, consult to your technical service.
- Check the Power Cord and Plug visually while cleaning the appliance. In case of deformation, consult to your technical service.

## Cleaning

Regular and careful cleaning helps your infrared heater operate efficiently for many trouble free years. To clean your heater follow the steps below:

1. Unplug the power cord for your safety before cleaning your appliance.
2. Make sure the heater is cool before continuing.
3. To keep the heater clean, the outer shell may be cleaned with a soft, damp cloth. You may use a mild detergent if necessary. After cleaning, dry the unit with a soft cloth. (CAUTION: DO NOT let liquids enter the heater).
4. DO NOT use alcohol, gasoline, abrasive powders, furniture polish or rough brushes to clean the heater. This may cause damage or deterioration to the surface of the heater.
5. DO NOT immerse the heater in water
6. Wait until the heater is completely dry before use.

Storage: Store the heater in a cool, dry location when not in use to prevent dust and dirt build up. Use packaging carton to store.

#### ATTENTION

- Always disconnect the heater from the electricity supply and allow it to cool before attempting to work on it.
- If the heater has collected dust or dirt inside the unit or around the heating element, have the unit cleaned by a qualified service agent. Do not operate the heater in this condition.
- The only maintenance required is cleaning of the external surfaces of the heater.
- Do not use powerful abrasive or solvent cleaning fluids when cleaning the heater as they may damage the plastic parts. Use a damp cloth to wipe the outside of the heater.
- If removed from its mounting position when not in use, store the heater carefully in a safe, dry, childproof location.
- Do not touch the heating element with bare fingers, as residue from your hand could affect the life of the lamp. If it is accidentally touched, remove the finger marks with a soft cloth moistened with methylated spirit or alcohol.
- Do not attempt to repair or adjust any electrical or mechanical functions on this heater.
- The heater contains no user serviceable parts. Should the product suffer damage or breakdown, it must be returned to the supplier.
- Damaged supply cords to be replaced by the supplier.

tranquillity  
bathroomware

**Tranquillity New Zealand Ltd**  
T 0800 805 558 W [www.tbw.co.nz](http://www.tbw.co.nz)



E7023